

GINTEC R60 Controller User Manual



1/5/2023

1 Introduction

This chapter mainly introduces R60 product appearance and accessories. The product appearance includes panel, keyboard and interface.

▪ 1.1 Panel

1.1.1 Front side of R60

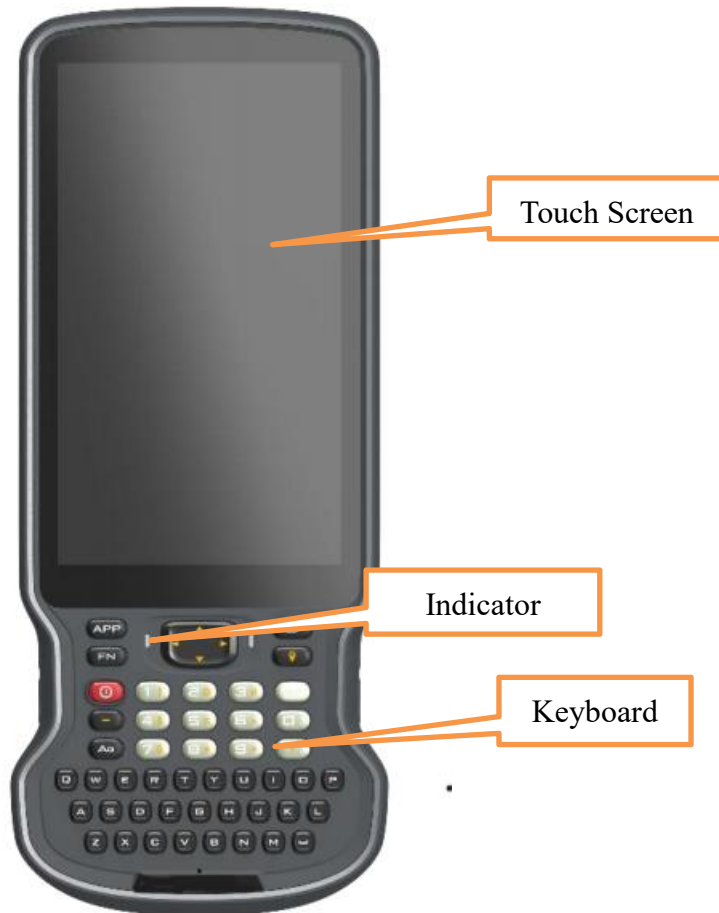

Chart 1-1 Function description of the front component of the controller

Component	Description
Indicator Light	Charge state lamp
Touch Screen	Capacitive screen, multi touch, wet hand touch, support active capacitive pen and glove touch
Keyboard	Switch on / off, direction control, Chinese and English switching input, data acquisition and other functions

1.1.2 Back side of R60



Chart 1-2 Function description of the back component of the controller

Component	Description
Flash lamp	Support photo taking and flashlight function
SIM Card Slot	nano SIM card slot
Horn	Real time voice broadcast of instrument operation and status

Camera	Be used for on-site acquisition of image information
NFC	Support NFC data transmission function and realize intelligent pairing between RTK and hand
Bracelet	Strengthen handheld stability

• 1.2 Keyboard



Chart 1-3 Function description of keyboard

Component	Description
Fn Key	Switch between numbers and symbols. Press the power key + FN combination key when starting up to enter the brush interface
Cross Navigation Key	Up, down, left and right direction keys
Delete Key	Backspace delete
Return/Home Key	Return to the previous page or long press to return to the main page of the manual
Aa Key	Input method case switching
Space Key	Input space

Acquisition Key	Manual data acquisition
Letter Keys	English input
Power Key	Start / close the handheld controller and turn off the screen (double click to quickly screenshot, press and hold for 8 seconds to forcibly restart the machine)

• 1.3 Accessories

Charger



Charger: 5V—1.67A/7V—1.67A/9V—1.67A Model: L003IT-016C

Data line



USB data line: Connect with the USB port of the computer for data transmission.

Connect with USB port of charger for charging the handheld controller.

• 1.4 Handheld Controller Charging

1.4.1 Battery

R60 handheld controller adopts built-in 9000mA high-capacity lithium battery without installation and disassembly.

1.4.2 Charge

A special charger should be used to charge within a certain temperature range and a certain charging time is required.

Specific usage and requirements: the special charger standard for R60 should be used. When you use it for the first time, there is still a certain amount of electricity in the battery. You should use up the electricity before charging. R60 supports fast charging, but the original charger must be used, and the charging time is less than 4 hours. If the battery is not used frequently, it must be charged once every two months.

▪ 1.5 Handheld Controller Application

1.5.1 SIM Card Installation

This controller uses the Nano SIM/UIM card. First unscrew the screws on the back cover, insert the SIM/UIM card into the lower card slot, and insert the TF card into the upper card slot

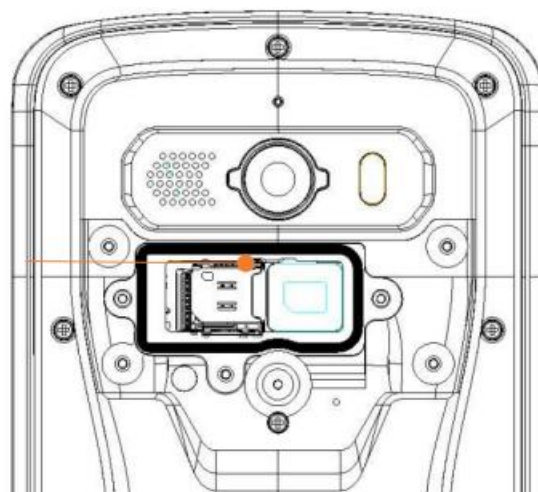
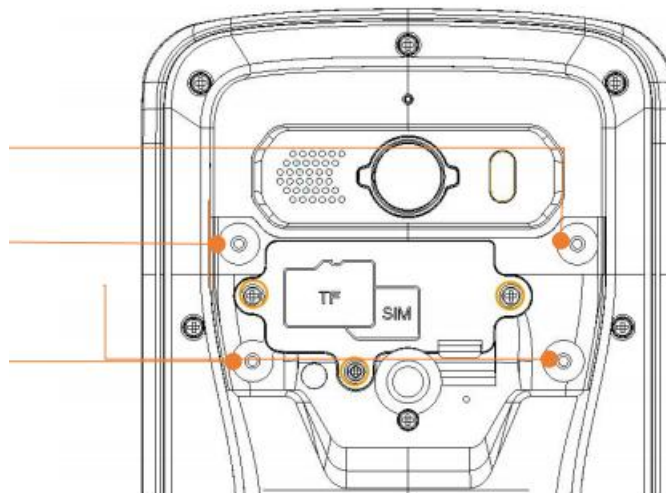

1.5.2 on/off operation

1. shutdown status, long press the power button for 3 seconds, and the handheld controller vibrates at the same time to start the machine.

2. In the power on status, long press the power button for 3 seconds to prompt for shutdown confirmation, and then click "Power off".

3. **Forced restart:** press and hold the power key for 12 seconds to forcibly restart the manual

4. **Enter recovery mode:** when the machine is turned off, press and hold the "Up" key of the keyboard, and press briefly at the same time. When the power key vibrates to the motor, release the power key, and keep pressing the "Up" key on the keyboard for a long time, then Nocommand green page appears. In the color robot interface, when all keys are released, press the power key again for a long time and press the up key for a short time to enter recovery mode

1.5.3 The connection between handheld controller and PC

1. Connect R60 and PC by USB data line.

2. Transfer files: Drop down screen top menu, click (USB for file transfer), select (File Transfer).

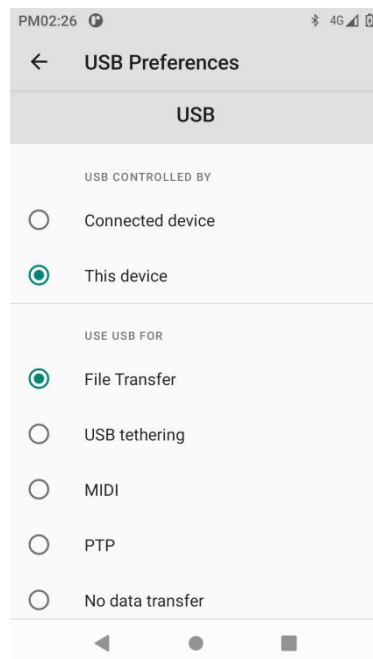

1.5.4 Typewriting

1. During the use of Typewriting, there are mainly two switching keys, Fn and Aa.

2. The typewriting is set successfully. During the process of using the typewriting, each time a new input dialog box is opened, the default current state of the typewriting is digital state and lowercase letter state.

3. Fn key and its functional requirement: click Fn key, switch numbers to characters and cycle them in turn.

4. Aa key and its functional requirement: click Aa key, switch from lowercase letters to uppercase letters, then click Aa, switch from uppercase letters to Chinese, and then click AA to return to lowercase letters, and switch in turn.

5. Up, down, left, right and enter to select and confirm the input.

▪ 1.6 Bluetooth connection

Method 1: Bluetooth connection

Method 1: Bluetooth connect by SurPad

You need to turn on the device, and then perform the following operations on the R60.

1. Turn on SurPad, click “Device” → “Communication” .
2. Select correct Device manufacturer and Device Type, and then select

Bluetooth in Communication Mode.

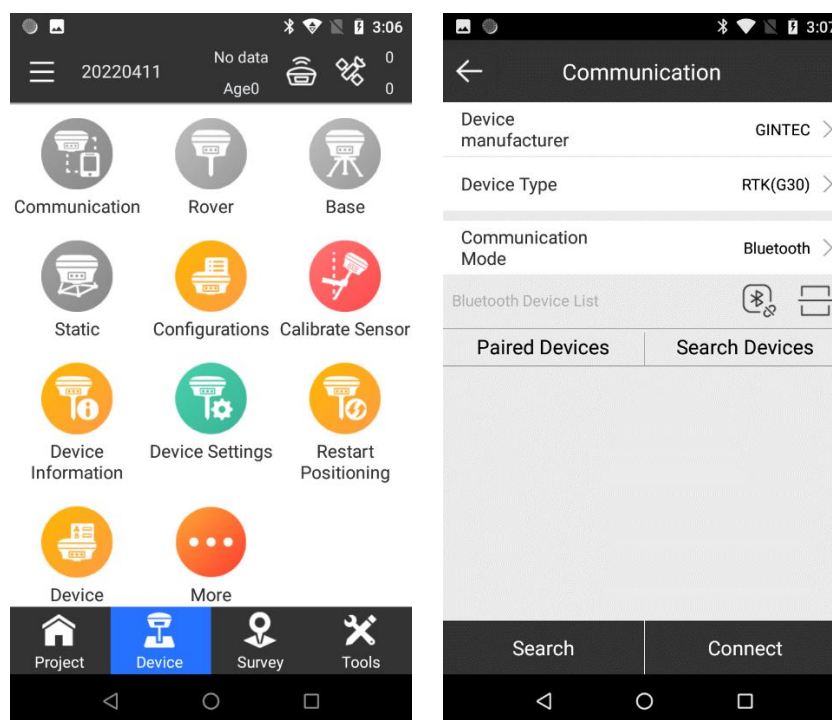

3. Click Search, you can search for nearby Bluetooth devices.
4. Select the device to be connected and click Connect to connect to Bluetooth.

1.7 SurPad software installation

Step1: Connect H6 and PC by USB data line, and drop down screen top menu, click (USB for file transfer), select (transfer files).

Step2: Enter Drive Management on the computer, and click H8.



Step3: Click “Internal shared storage”, and then drag the SurPad installation package to the bottom.

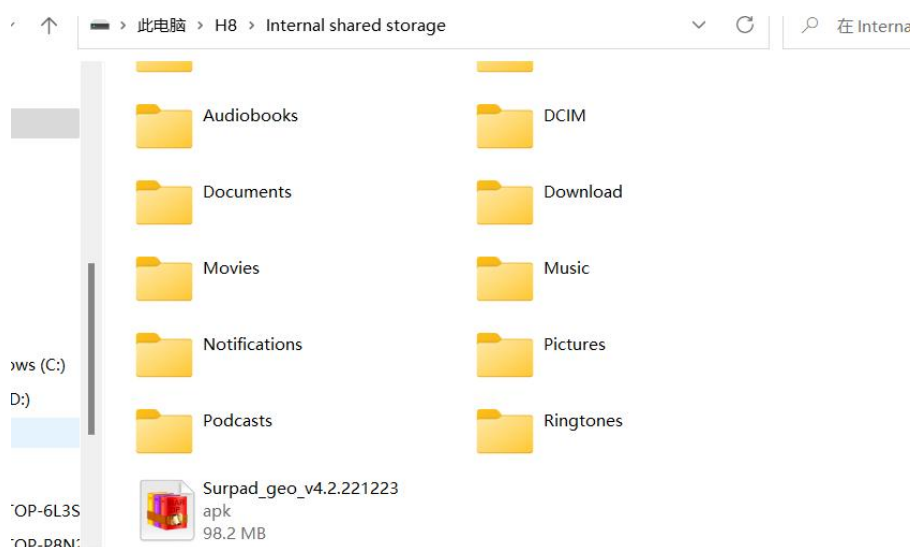

Step4: Turn on the handheld controller, click “File” from APP interface, and find the installation package at the bottom and click Install.

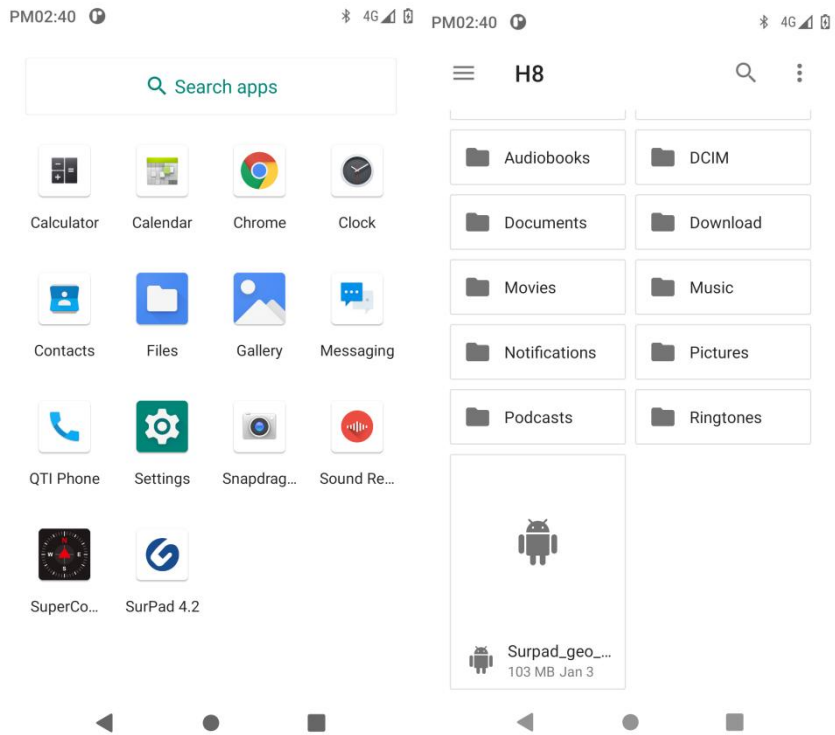

1.8 Parameters

Operation system	Android 11
CPU	Qualcomm chip
Storage	4GB+64GB
External storage	Support
Screen	5.5inch
Display resolution	1920*1080, 500nit
Camera	13 million pixels
Key	Full function keyboard
USB	Type-c, support OTG

Card slot	SD card;SIM card
Bluetooth	BT5.0
WIFI	WIFI6; 802.11a/b/g/n; 2.4G/5G
NFC	Support
GSM	850/900/1800/1900
WCDMA	B1/B2/B4/B5/B8
LTE-TDD	B38/B39/B40/B41
LTE-FDD	B1/B2/B3/B4/B5/B7/B8/B12/B13/B17 B20/B25/B26/B28
Internal battery	9000mAh
Adapter	Type-c; Support fast charging
Operating time	Above 20 hours
Dimension	219.6*91.2*21.2mm
Weight	410g
Operating temperature	-25°C to +60°C
Storage temperature	-30°C to +70°C
Protection class	IP68; Resistance to 1.8m drop